

# Zinox Frame Penta C2 G22-23

## 301020220

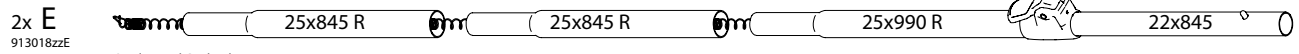

Samles med CM-kryds

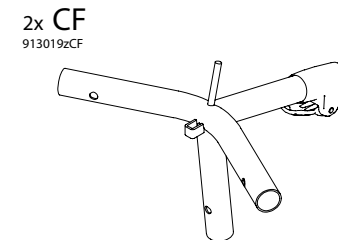
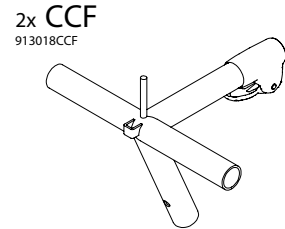
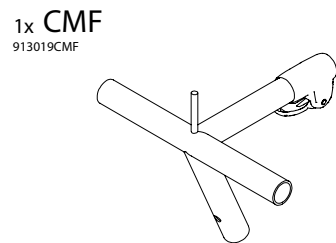
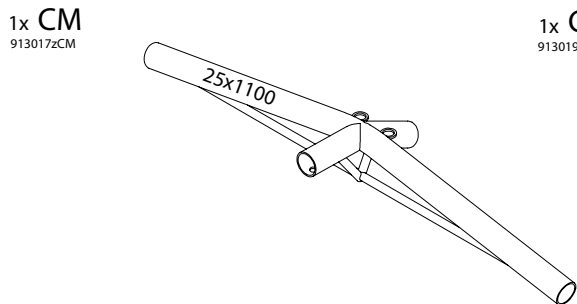
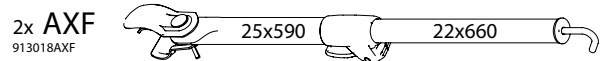
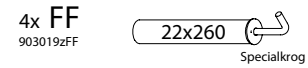
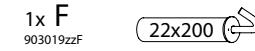
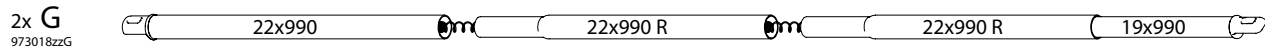
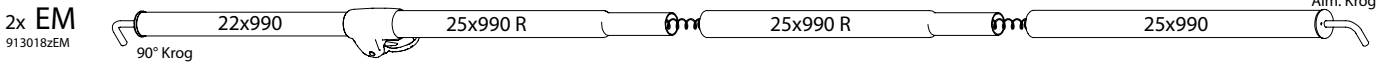

| Pakkelliste / Packing list  |          | Stk. / Qty. |        |
|-----------------------------|----------|-------------|--------|
| Carton                      |          | Large       |        |
| Stangpose / Pole bag, large |          | 2           |        |
| Dato/Date                   | Rev. no. | Units       | Weight |
| 06-02-2023                  | 06       | mm          | -,- kg |

